

DTP08-250KG-R1260-SP-Ex

SWL - 250kg

AUTOMATIC DRUM CATC
FOR 50-220L STEEL
AND PLASTIC DRUMS

LADDER RACK OFFERS
VERTICAL HEIGHT
ADJUSTMENT FOR
DIFFERENT DRUM SIZES

1260MM LIFT HEIGHT
HYDRAULIC RAM
FITTED WITH BURST VALVE

ALL WHEELS CONTAIN
PRECISION BEARINGS

160MM ANTI-STATIC WHEELS

CLEAN MILD STEEL CONSTRUCTION WITH
POWDERCOATED FINISH IN RAL 5010 (BLUE)

MANUAL HYDRAULIC
LIFT HAND PUMP AND TANK WITH
THROTTLING LOWERING VALVE

2X 100MM OUTRIGGER
ANTI-STATIC CASTORS
FOR STABILITY

CLEAR ANTI-STATIC
POLYCARBONATE
GUARDING

STAINLESS STEEL TILLER
HANDLE WITH SPRING RETURN

BRAKED SINGLE WHEEL REAR STEERING
WITH PRECISION BEARINGS
FOR MAXIMUM MANOEUVRABILITY

FITTED WITH EARTHING CHAINS

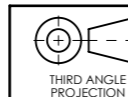

ALL DIMENSIONS
IN mm U.O.S
DO NOT SCALE



BESPOKE HANDLING EQUIPMENT LTD
LEEDSTOWN, CORNWALL, TR27 6DS
TEL: +44 1736 85 10 50 FAX: +44 1736 85 10 23
E-MAIL: SALES@STS-TROLLEYS.CO.UK
WWW: HTTPS://WWW.STS-TROLLEYS.CO.UK

CUSTOMER APPROVAL:

NAME:
SIGNATURE:
DATE:

THIS DOCUMENT AND ALL THE INFORMATION CONTAINED HEREIN ARE CONFIDENTIAL AND EXCLUSIVE PROPERTY OF STS BESPOKE HANDLING EQUIPMENT AND MAY NOT BE REPRODUCED, USED, DISCLOSED OR MADE PUBLIC IN ANY MANNER PRIOR TO EXPRESS WRITTEN AUTHORIZATION BY STS BESPOKE HANDLING EQUIPMENT. THIS DOCUMENT IS ACCEPTED PURSUANT TO AGREEMENT TO THE FOREGOING, AND MUST BE RETURNED OR DESTROYED UPON DEMAND. MANUFACTURER AGREES THAT ARTICLES MADE IN ACCORDANCE WITH THIS DOCUMENT SHALL BE CONSIDERED STS BESPOKE HANDLING EQUIPMENT'S DESIGN AND THAT IDENTICAL ARTICLES OR PARTS THEREOF SHALL NOT BE MANUFACTURED FOR THE USE OR SALE BY THE MANUFACTURER OR ANY OTHER PERSON OR ENTITY WITHOUT PRIOR EXPRESS WRITTEN AUTHORIZATION BY STS BESPOKE HANDLING EQUIPMENT.

CATEGORY: ASSEMBLY

MATERIAL SPEC:

FINISH: N/A

DESCRIPTION: DTP08 DEPALLETISER, 1260 STROKE, 250KG SWL, ATEX, DTP08-250KG-R1260-SP-EX

SHEET NO: 1 OF 4

EST MASS: 442.24kg

SHEET SIZE: A3

PART NUMBER:
017692



DRAWN BY: JS

CHECKED BY:

DATE
CHK:

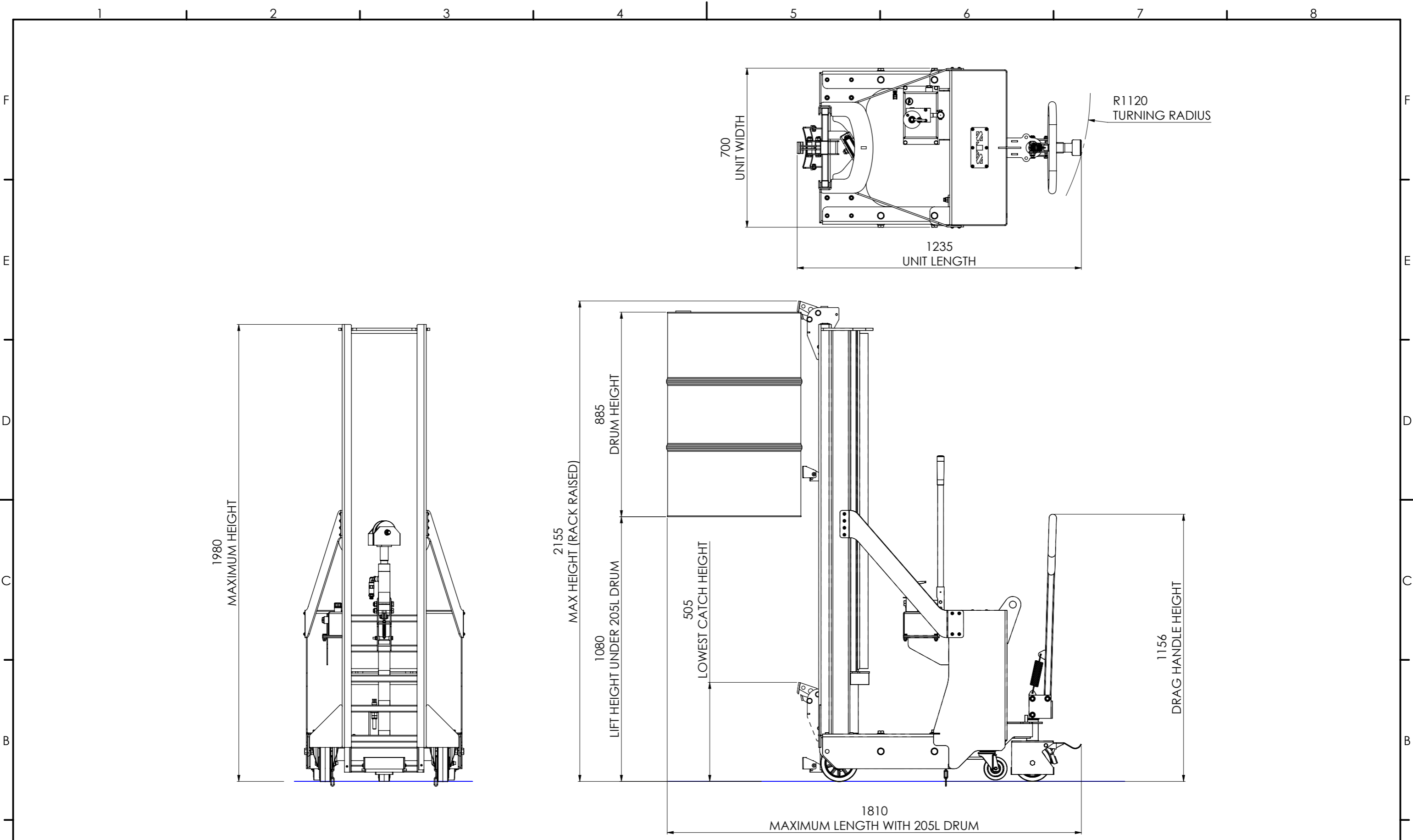
REVISION:
A



 THIRD ANGLE PROJECTION	ALL DIMENSIONS IN mm U.O.S DO NOT SCALE	CUSTOMER APPROVAL: NAME: SIGNATURE: DATE:	CATEGORY: ASSEMBLY MATERIAL SPEC: FINISH: N/A	SHEET NO: 2 OF 4 EST MASS: 442.24kg SHEET SIZE: A3 PART NUMBER: 017692	DRAWN BY: JS CHECKED BY: DATE CHK: REVISION: A
	 BESPOKE HANDLING EQUIPMENT LTD LEEDSTOWN, CORNWALL, TR27 6DS TEL: +44 1736 85 10 50 FAX: +44 1736 85 10 23 E-MAIL: SALES@STS-TROLLEYS.CO.UK WWW: HTTPS://WWW.STS-TROLLEYS.CO.UK	<small>THIS DOCUMENT AND ALL THE INFORMATION CONTAINED HEREIN ARE CONFIDENTIAL AND EXCLUSIVE PROPERTY OF STS BESPOKE HANDLING EQUIPMENT AND MAY NOT BE REPRODUCED, USED, DISCLOSED OR MADE PUBLIC IN ANY MANNER PRIOR TO EXPRESS WRITTEN AUTHORIZATION BY STS BESPOKE HANDLING EQUIPMENT. THIS DOCUMENT IS ACCEPTED PURSUANT TO AGREEMENT TO THE FOREGOING, AND MUST BE RETURNED OR DESTROYED UPON DEMAND. MANUFACTURER AGREES THAT ARTICLES MADE IN ACCORDANCE WITH THIS DOCUMENT SHALL BE CONSIDERED STS BESPOKE HANDLING EQUIPMENT'S DESIGN AND THAT IDENTICAL ARTICLES OR PARTS THEREOF SHALL NOT BE MANUFACTURED FOR THE USE OR SALE BY THE MANUFACTURER OR ANY OTHER PERSON OR ENTITY WITHOUT PRIOR EXPRESS WRITTEN AUTHORIZATION BY STS BESPOKE HANDLING EQUIPMENT.</small>	DESCRIPTION: DTP08 DEPALLETISER, 1260 STROKE, 250KG SWL, ATEX, DTP08-250KG-R1260-SP-EX	REVISION: 01 AUTHOR: JC AUTHORISER: NV	PRINTED ON: 02/11/2020

1 2 3 4 5 6 7 8

F

E

D



C

B

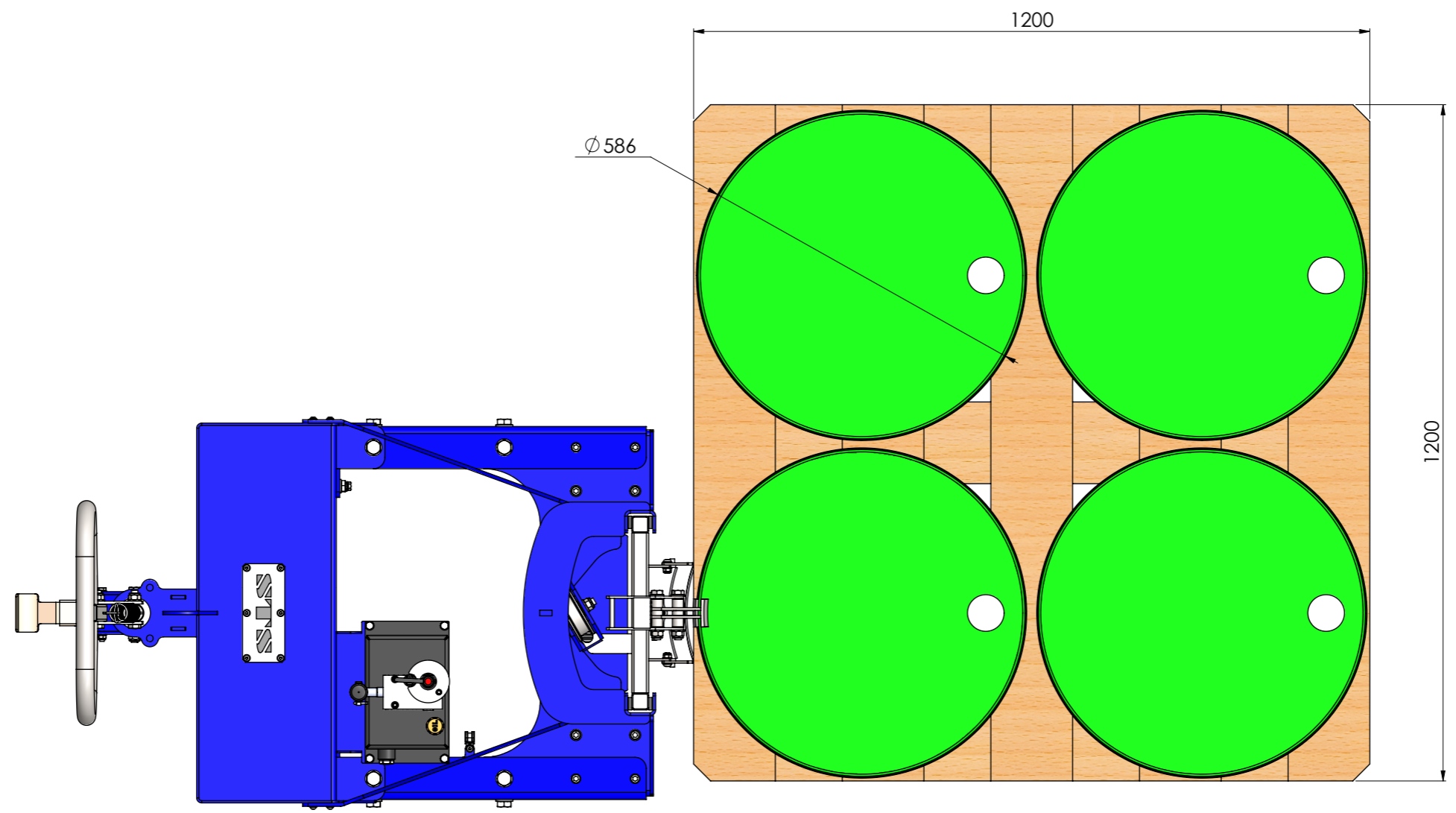
A

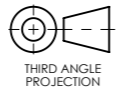

USING THE DEPALLETER FOR UNLOADING/LOADING A 1200MM X 1200MM PALLET

 THIRD ANGLE PROJECTION	ALL DIMENSIONS IN mm U.O.S DO NOT SCALE	CUSTOMER APPROVAL: NAME: SIGNATURE: DATE:	CATEGORY: ASSEMBLY MATERIAL SPEC: FINISH: N/A	SHEET NO: 3 OF 4 EST MASS: 442.24kg SHEET SIZE: A3 PART NUMBER: 017692	DRAWN BY: JS CHECKED BY: DATE CHK: REVISION: A
	 BESPOKE HANDLING EQUIPMENT LTD LEEDSTOWN, CORNWALL, TR27 6DS TEL: +44 1736 85 10 50 FAX: +44 1736 85 10 23 E-MAIL: SALES@STS-TROLLEYS.CO.UK WWW: HTTPS://WWW.STS-TROLLEYS.CO.UK	<small>THIS DOCUMENT AND ALL THE INFORMATION CONTAINED HEREIN ARE CONFIDENTIAL AND EXCLUSIVE PROPERTY OF STS BESPOKE HANDLING EQUIPMENT AND MAY NOT BE REPRODUCED, USED, DISCLOSED OR MADE PUBLIC IN ANY MANNER PRIOR TO EXPRESS WRITTEN AUTHORIZATION BY STS BESPOKE HANDLING EQUIPMENT. THIS DOCUMENT IS ACCEPTED PURSUANT TO AGREEMENT TO THE FOREGOING, AND MUST BE RETURNED OR DESTROYED UPON DEMAND. MANUFACTURER AGREES THAT ARTICLES MADE IN ACCORDANCE WITH THIS DOCUMENT SHALL BE CONSIDERED STS BESPOKE HANDLING EQUIPMENT'S DESIGN AND THAT IDENTICAL ARTICLES OR PARTS THEREOF SHALL NOT BE MANUFACTURED FOR THE USE OR SALE BY THE MANUFACTURER OR ANY OTHER PERSON OR ENTITY WITHOUT PRIOR EXPRESS WRITTEN AUTHORIZATION BY STS BESPOKE HANDLING EQUIPMENT.</small>		DESCRIPTION: DTP08 DEPALLETER, 1260 STROKE, 250KG SWL, ATEX, DTP08-250KG-R1260-SP-EX	REVISION: 01 AUTHOR: JC AUTHORISER: NV 8 PRINTED ON: 02/11/2020

1 2 3 4 5 6 7 8