

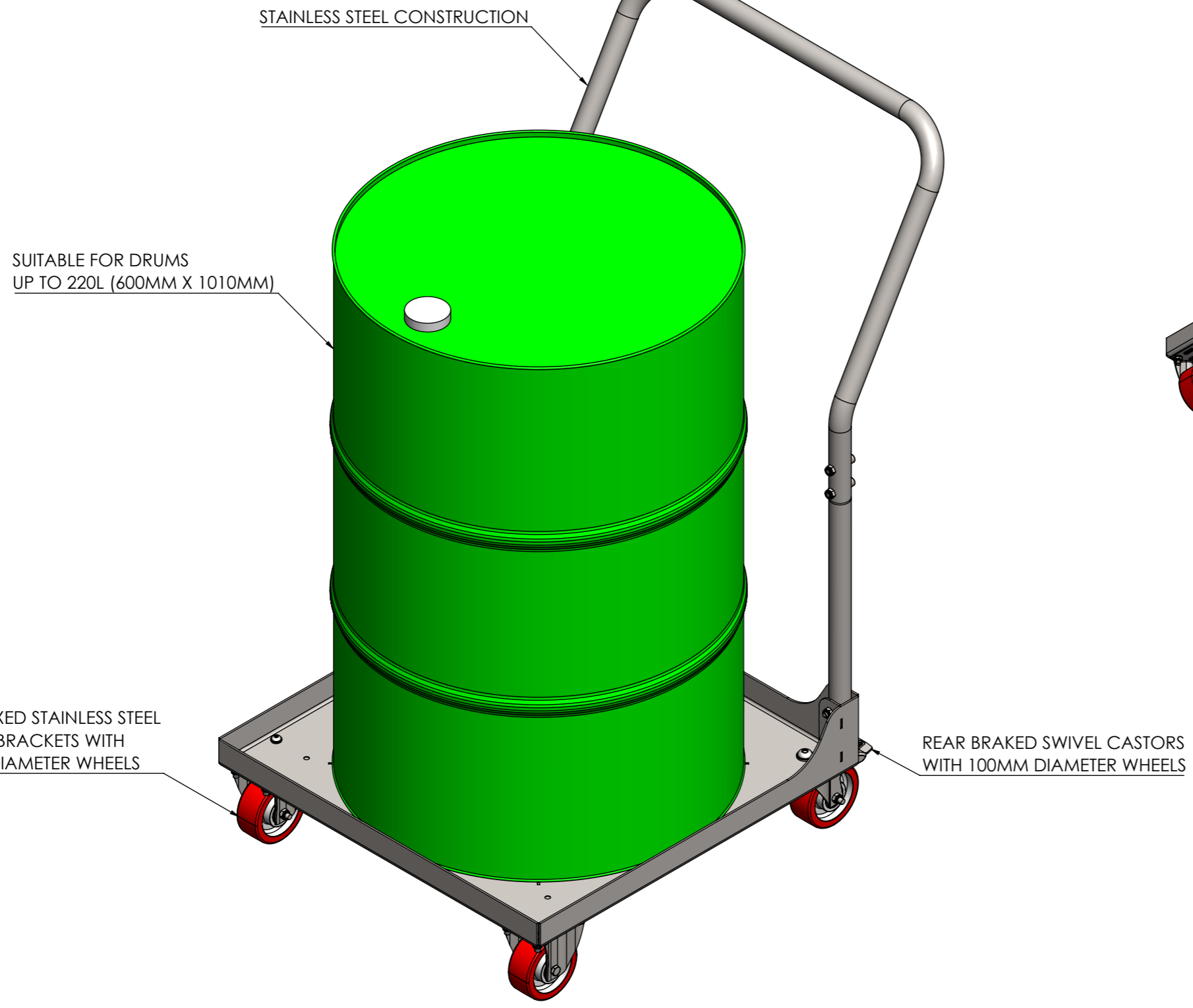

DDL200-SS

SWL 350KG

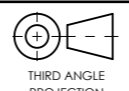

 THIRD ANGLE PROJECTION	ALL DIMENSIONS IN mm U.O.S	DESCRIPTION: DDL200-SS, DRUM DOLLY ASSEMBLY, W/ SPILL TRAY, F/ MAX 600MM DIAMETER DRUM, STAINLESS STEEL, 350KG SWL	SHEET NO: 1 OF 2
	DO NOT SCALE		DRAWN BY: JS
		CUSTOMER APPROVAL: NAME: SIGNATURE: DATE:	SHEET SIZE: A3
<small> BESPOKE HANDLING EQUIPMENT LTD LEEDSTOWN, CORNWALL, TR27 6DS TEL: +44 1736 85 10 50 FAX: +44 1736 85 10 23 E-MAIL: SALES@STIS-TROLLEYS.CO.UK WWW: HTTPS://WWW.STIS-TROLLEYS.CO.UK </small>			<small> THIS DOCUMENT AND ALL THE INFORMATION CONTAINED HEREIN ARE CONFIDENTIAL AND EXCLUSIVE PROPERTY OF STS BESPOKE HANDLING EQUIPMENT AND MAY NOT BE REPRODUCED, USED, DISCLOSED OR MADE PUBLIC IN ANY MANNER PRIOR TO EXPRESS WRITTEN AUTHORIZATION BY STS BESPOKE HANDLING EQUIPMENT. THIS DOCUMENT IS ACCEPTED PURSUANT TO AGREEMENT TO THE FOREGOING, AND MUST BE RETURNED OR DESTROYED UPON DEMAND. MANUFACTURER AGREES THAT ARTICLES MADE IN ACCORDANCE WITH THIS DOCUMENT SHALL BE CONSIDERED STS BESPOKE HANDLING EQUIPMENT'S DESIGN AND THAT IDENTICAL ARTICLES OR PARTS THEREOF SHALL NOT BE MANUFACTURED FOR THE USE OR SALE BY THE MANUFACTURER OR ANY OTHER PERSON OR ENTITY WITHOUT PRIOR EXPRESS WRITTEN AUTHORIZATION BY STS BESPOKE HANDLING EQUIPMENT. </small>

1 2 3 4 5 6 7 8

F

E

D

C

B

A

F

E

D



C

B

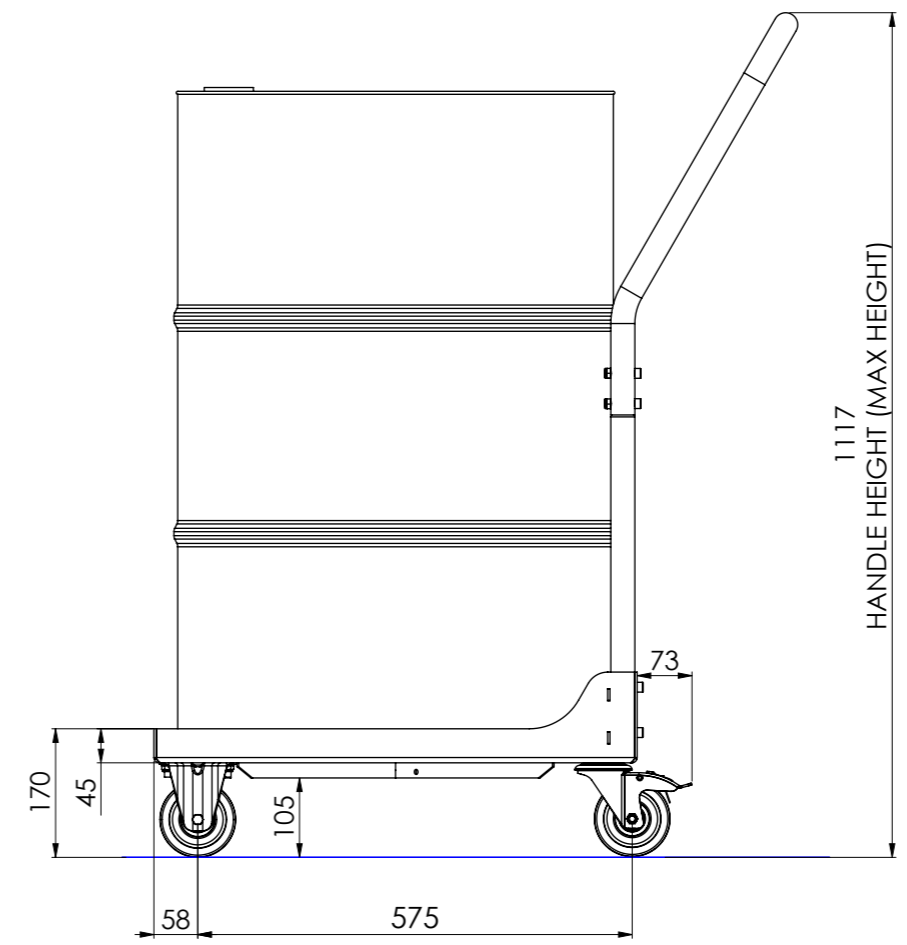
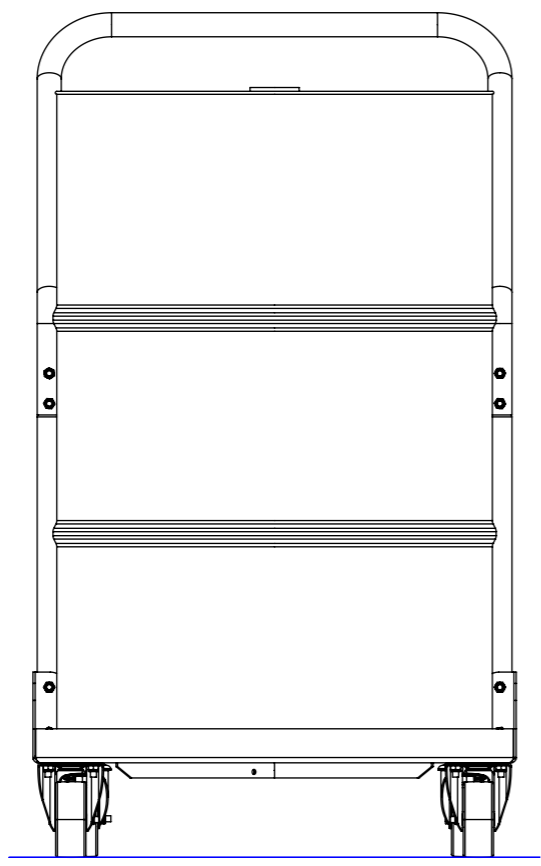
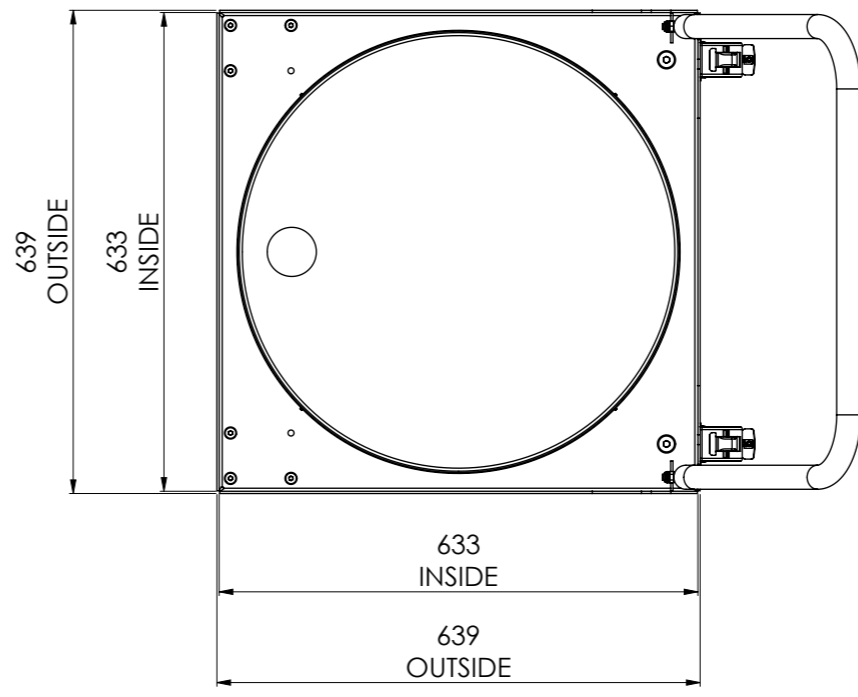
A

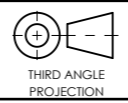

NOTE: 200L DRUM SHOWN

 THIRD ANGLE PROJECTION	ALL DIMENSIONS IN mm U.O.S DO NOT SCALE	DESCRIPTION: DDL200-SS, DRUM DOLLY ASSEMBLY, W/ SPILL TRAY, F/ MAX 600MM DIAMETER DRUM, STAINLESS STEEL, 350KG SWL	SHEET NO: 2 OF 2
	 BESPOKE HANDLING EQUIPMENT LTD LEEDSTOWN, CORNWALL, TR27 6DS TEL: +44 1736 85 10 50 FAX: +44 1736 85 10 23 E-MAIL: SALES@STS-TROLLEYS.CO.UK WWW: HTTPS://WWW.STS-TROLLEYS.CO.UK		CUSTOMER APPROVAL: NAME: SIGNATURE: DATE:
<small>THIS DOCUMENT AND ALL THE INFORMATION CONTAINED HEREIN ARE CONFIDENTIAL AND EXCLUSIVE PROPERTY OF STS BESPOKE HANDLING EQUIPMENT AND MAY NOT BE REPRODUCED, USED, DISCLOSED OR MADE PUBLIC IN ANY MANNER PRIOR TO EXPRESS WRITTEN AUTHORIZATION BY STS BESPOKE HANDLING EQUIPMENT. THIS DOCUMENT IS ACCEPTED PURSUANT TO AGREEMENT TO THE FOREGOING, AND MUST BE RETURNED OR DESTROYED UPON DEMAND. MANUFACTURER AGREES THAT ARTICLES MADE IN ACCORDANCE WITH THIS DOCUMENT SHALL BE CONSIDERED STS BESPOKE HANDLING EQUIPMENT'S DESIGN AND THAT IDENTICAL ARTICLES OR PARTS THEREOF SHALL NOT BE MANUFACTURED FOR THE USE OR SALE BY THE MANUFACTURER OR ANY OTHER PERSON OR ENTITY WITHOUT PRIOR EXPRESS WRITTEN AUTHORIZATION BY STS BESPOKE HANDLING EQUIPMENT.</small>		SHEET SIZE: A3	
PART NUMBER: 020344			