

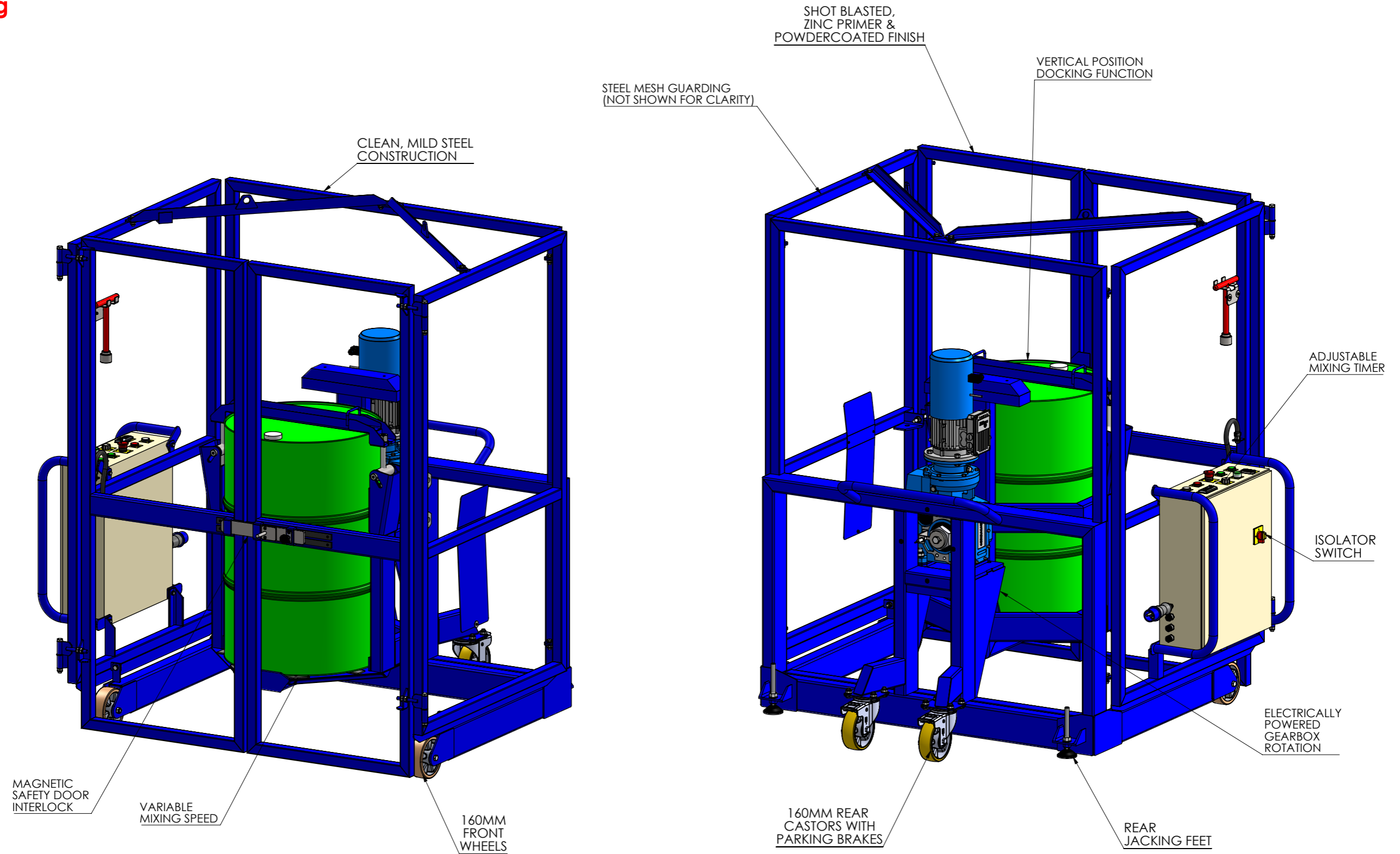

# DME01-230V-24RPM

SWL - 300kg

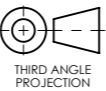

 THIRD ANGLE PROJECTION	ALL DIMENSIONS IN mm U.O.S. DO NOT SCALE	UNLESS OTHERWISE SPECIFIED THE FOLLOWING APPLY: FABRICATED COMPONENTS DIMENSIONAL PRECISION DECIMAL METRIC IMPERIAL ANGLE 0.0 ±1.20mm ±0.05" ±0.50" SIZE ≤ 1000MM 0.0 ±0.80mm ±0.03" ±0.25" SIZE ≤ 1000MM 0.0 ±2.5mm ±0.10" ±0.50" SIZE > 1000MM 0.0 ±1.5mm ±0.06" ±0.25" SIZE > 1000MM STANDARD SURFACE FINISH RA 63MM [RA 250MIN] BREAK ALL SHARP CORNERS AND EDGES, R 0.3mm MAX	CATEGORY: ASSEMBLY	SHEET NO: 1 OF 4	DRAWN BY: JS
				MATERIAL SPEC:	EST MASS: 0.00kg
 BESPOKE HANDLING EQUIPMENT LTD LEEDSTOWN, CORNWALL, TR27 6DS TEL: +44 1736 85 10 50 FAX: +44 1736 85 10 23 E-MAIL: SALES@STS-TROLLEYS.CO.UK WWW: HTTPS://WWW.STS-TROLLEYS.CO.UK			FINISH: N/A	SHEET SIZE: A3	DATE CHK: 24/01/2020
			DESCRIPTION: ELECTRIC DRUM MIXER, W/ HELICAL BEVEL GEARBOX, 24RPM, DME01-230V-24RPM	PART NUMBER: 014754	REVISION: A

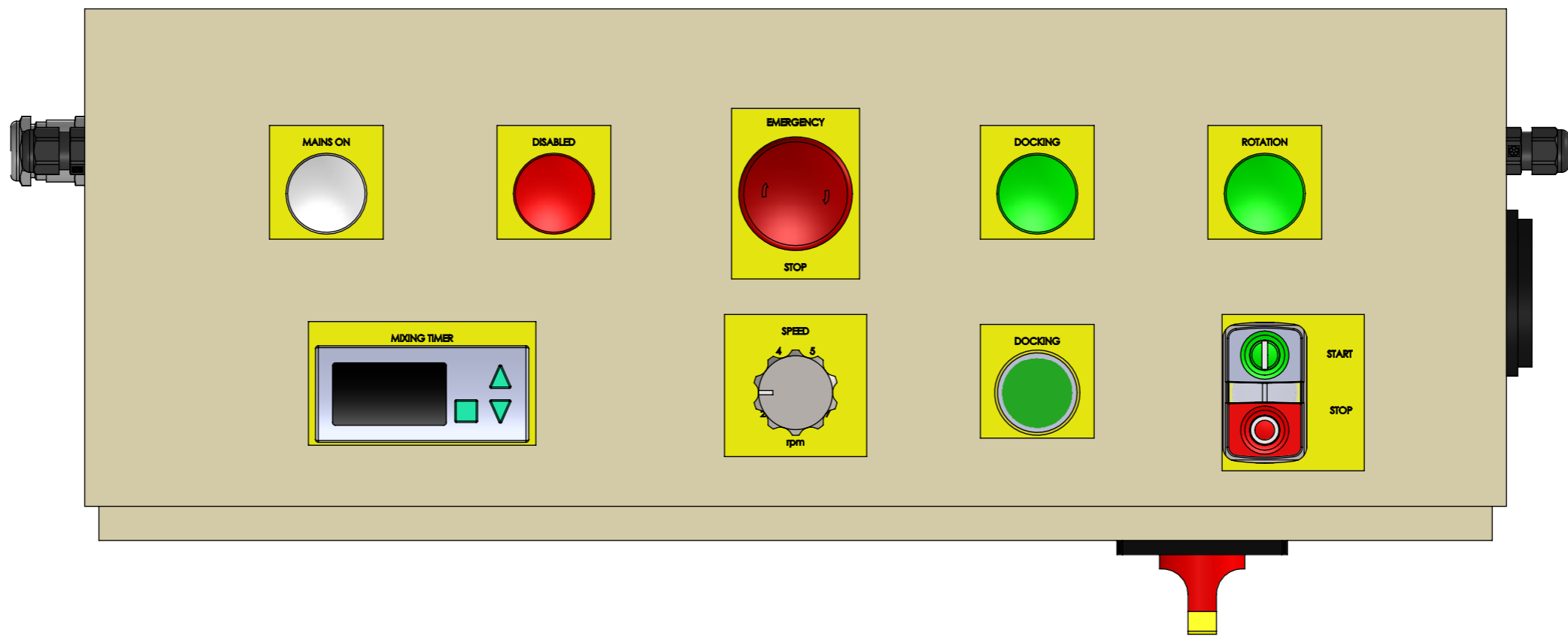

## CONTROL PANEL LAYOUT

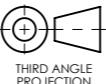
 THIRD ANGLE PROJECTION	ALL DIMENSIONS IN mm U.O.S. DO NOT SCALE	UNLESS OTHERWISE SPECIFIED THE FOLLOWING APPLY: FABRICATED COMPONENTS DIMENSIONAL PRECISION DECIMAL METRIC IMPERIAL ANGLE 0.0 ±1.20mm ±0.05° ±0.50° SIZE ≤ 1000MM 0.0 ±0.80mm ±0.03° ±0.25° SIZE ≤ 1000MM 0.0 ±2.5mm ±0.10° ±0.50° SIZE > 1000MM 0.0 ±1.5mm ±0.06° ±0.25° SIZE > 1000MM STANDARD SURFACE FINISH RA 63MM [RA 250MIN] BREAK ALL SHARP CORNERS AND EDGES, R 0.3mm MAX	CATEGORY: ASSEMBLY	SHEET NO: 2 OF 4	DRAWN BY: JS
				MATERIAL SPEC:	EST MASS: 0.00kg
			FINISH: N/A	SHEET SIZE: A3	DATE CHK: 24/01/2020
			DESCRIPTION: ELECTRIC DRUM MIXER, W/ HELICAL BEVEL GEARBOX, 24RPM, DME01-230V-24RPM	PART NUMBER: 014754	REVISION: A

  
**STS**  
 BESPOKE HANDLING EQUIPMENT LTD  
 LEEDSTOWN, CORNWALL, TR27 6DS  
 TEL: +44 1736 85 10 50 FAX: +44 1736 85 10 23  
 E-MAIL: SALES@STS-TROLLEYS.CO.UK  
 WWW: HTTPS://WWW.STS-TROLLEYS.CO.UK

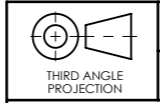
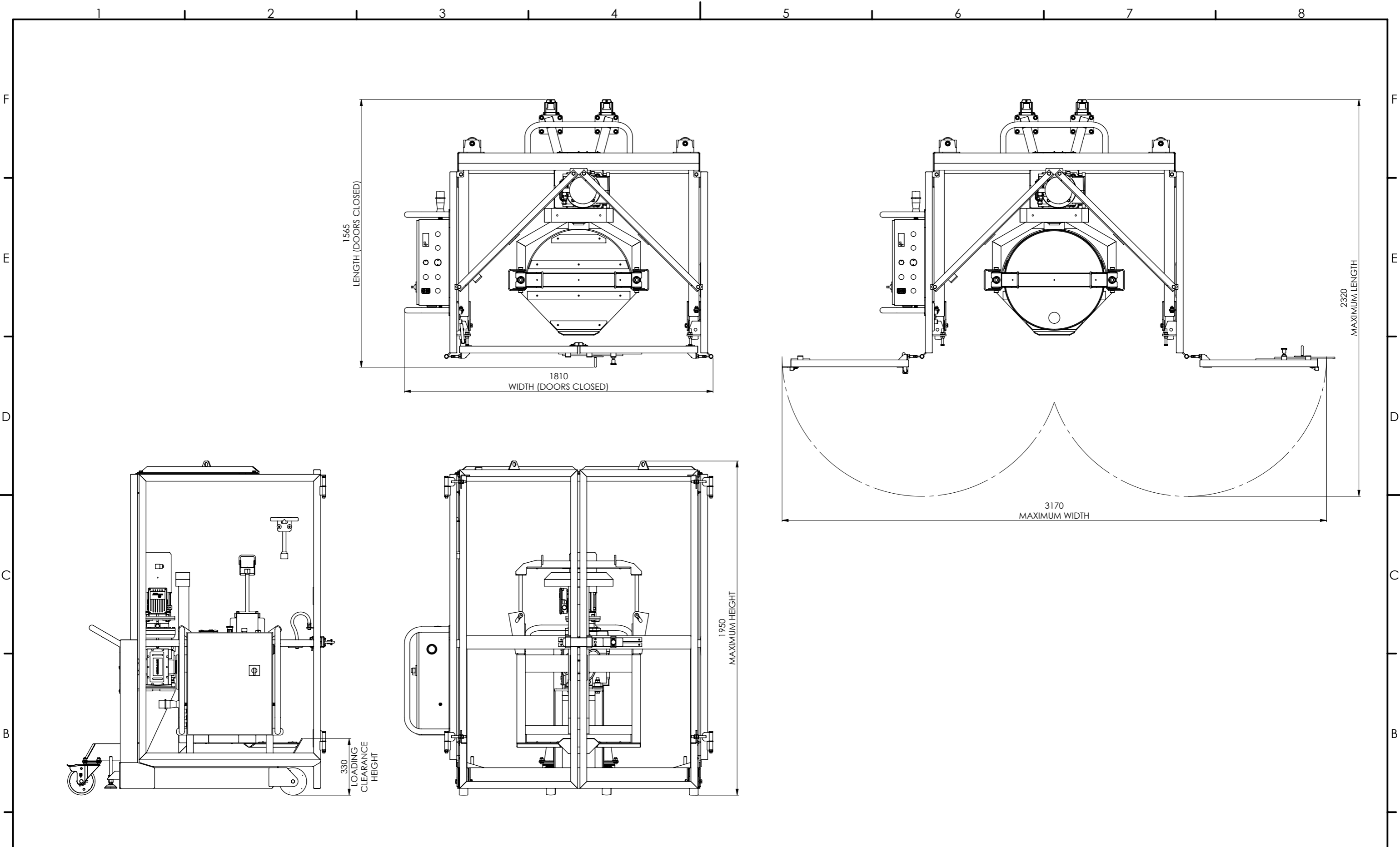

ALL DIMENSIONS  
IN mm U.O.S  
DO NOT SCALE



BESPOKE HANDLING EQUIPMENT LTD  
LEEDSTOWN, CORNWALL, TR27 6DS  
TEL: +44 1736 85 10 50 FAX: +44 1736 85 10 23  
E-MAIL: SALES@STS-TROLLEYS.CO.UK  
WWW: HTTPS://WWW.STS-TROLLEYS.CO.UK

UNLESS OTHERWISE SPECIFIED THE FOLLOWING APPLY:  
FABRICATED COMPONENTS DIMENSIONAL PRECISION  
DECIMAL METRIC IMPERIAL ANGLE  
0.1 ±1.20mm ±0.05° ±0.50° SIZE ≤ 1000MM  
0.0 ±0.80mm ±0.03° ±0.25° SIZE ≤ 1000MM  
0.0 ±2.5mm ±0.10° ±0.50° SIZE > 1000MM  
0.0 ±1.5mm ±0.06° ±0.25° SIZE > 1000MM  
STANDARD SURFACE FINISH RA 63MM [RA 250MIN]  
BREAK ALL SHARP CORNERS AND EDGES, R 0.3mm MAX

THIS DOCUMENT AND ALL THE INFORMATION CONTAINED HEREIN ARE CONFIDENTIAL AND EXCLUSIVE PROPERTY OF STS BESPOKE HANDLING EQUIPMENT AND MAY NOT BE REPRODUCED, USED, DISCLOSED OR MADE PUBLIC IN ANY MANNER PRIOR TO EXPRESS WRITTEN AUTHORIZATION BY STS BESPOKE HANDLING EQUIPMENT.  
THIS DOCUMENT IS ACCEPTED PURSUANT TO AGREEMENT TO THE FOREGOING, AND MUST BE RETURNED OR DESTROYED UPON DEMAND.  
MANUFACTURER AGREES THAT ARTICLES MADE IN ACCORDANCE WITH THIS DOCUMENT SHALL BE CONSIDERED STS BESPOKE HANDLING EQUIPMENT'S DESIGN AND THAT IDENTICAL ARTICLES OR PARTS THEREOF SHALL NOT BE MANUFACTURED FOR THE USE OR SALE BY THE MANUFACTURER OR ANY OTHER PERSON OR ENTITY WITHOUT PRIOR EXPRESS WRITTEN AUTHORIZATION BY STS BESPOKE HANDLING EQUIPMENT.

CATEGORY:	ASSEMBLY	SHEET NO:	3 OF 4	DRAWN BY:	JS
MATERIAL SPEC:		EST MASS:	0.00kg	CHECKED BY:	JS
FINISH:	N/A	SHEET SIZE:	A3	DATE CHK:	24/01/2020
DESCRIPTION:	ELECTRIC DRUM MIXER, W/ HELICAL BEVEL GEARBOX, 24RPM, DME01-230V-24RPM	PART NUMBER:	014754	REVISION:	A